



Rocking function type 139

Type 139

360° rotary system type 139







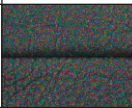

**BOOGIE:** EXTRAVAGANT DESIGN.

MAXIMUM COMFORT. PURE RELAXATION. OPTIONALLY AVAILABLE AS A ROTARY AND ROCKING CHAIR, ARMCHAIR, SOFA, LOUNGER AND RECAMIERE. ELEMENTS WITH A CUSHION LOOK ON A METAL BASE FRAME, MATT FINE STRUCTURE POWDER-COATED. LARGE SELECTION OF TEXTILES AND LEATHERS. UNIQUE PIECE PRODUCTION.

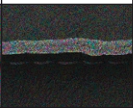

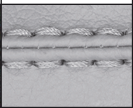
**Metal skids:** finestructure powder coated, 2 colours  
**Foot plate 139:** only available in black fine structure powder coated  
**Attention!** Maximum load with armchair type 139: up to 110 kg

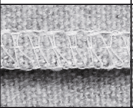
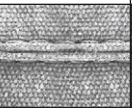
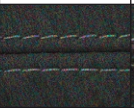
### Processing options of main seam / decorative seam

	Plain seam	Lap seam	Raw edged	Moccasin seam extra charge	Twin seam extra charge	KR* (zipper piping) extra charge	Overcast seam extra charge	Piping	Two needle seam	Square seam extra charge
										
Fabric	x									
Leather	x									
Fake fur	x									

If is possible to order main seam or decorative seam either tone in tone like the colours of cover or in the contrasting colours white, nature, grey, rust and black. On request spezial colours possible.

\*Zipper piping: optionally in the colours black, red, nature or light grey.

### Colours for metal skids

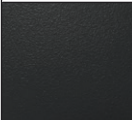
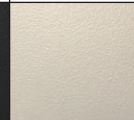
Black	Silk grey
	
✓	✓

**Model 0618 Boogie is also available as outdoor product!**

**For further informations refer to product information OD0618 Boogie.**

13.11.2024

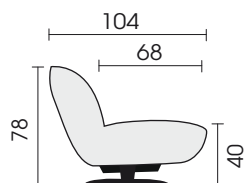

Side view (type 139)

Functional armchair:

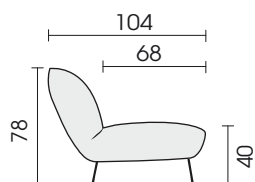
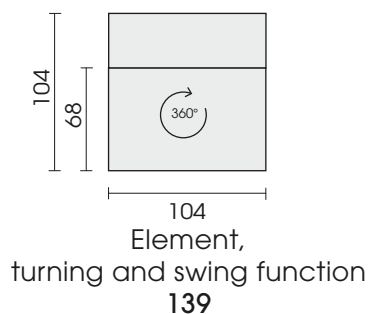

Side view (type 130)

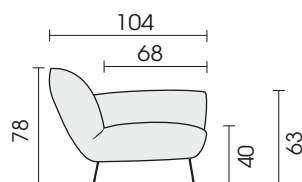

Side view (type 110/210)

▷ = Connector side

Solid elements:

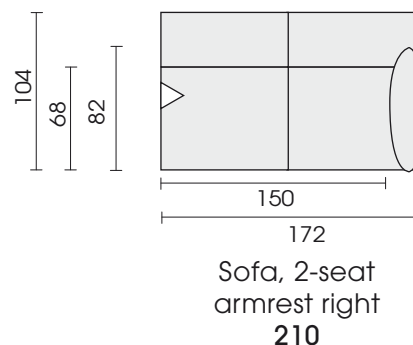
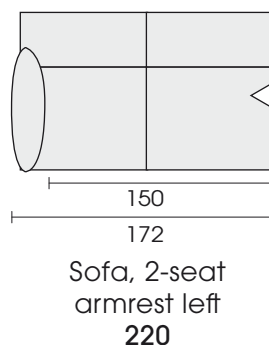
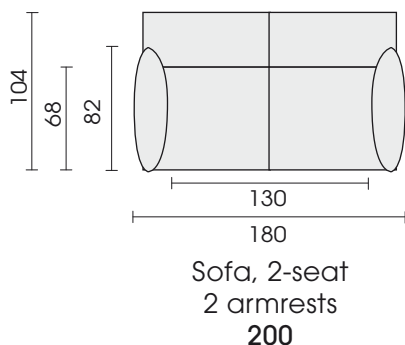
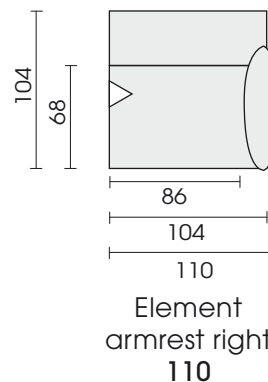
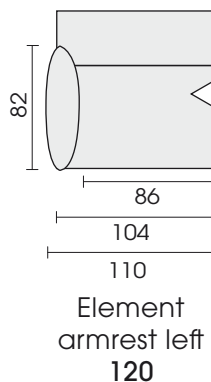
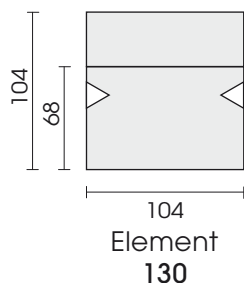

Each piece of furniture is handmade and unique. Deviations to the listed measurements may be caused by:  
 1. different upholstery materials (fabric, leather), 2. processing of ticking mats, 3. the pressure to combine individual parts, etc.  
 The seat comfort of a sofa type with larger seat depth usually differs from one with lower depth.

Deep elements:

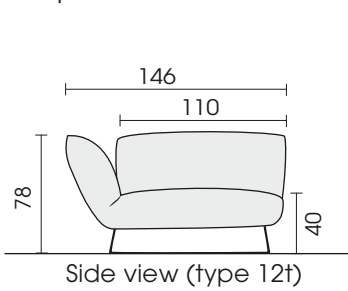

Side view (type 12t)

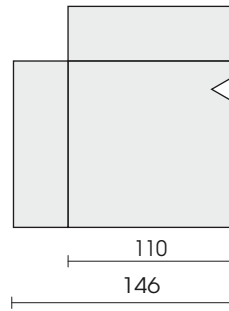

Element, deep height armrest left  
**12t**

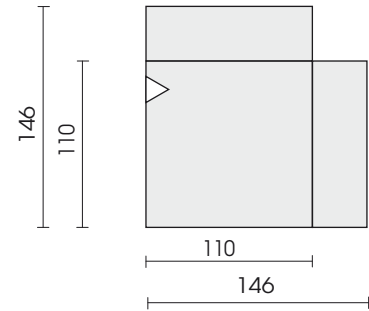

Element, deep height armrest right  
**11t**

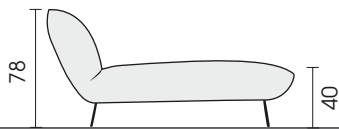

Side view (type 400)

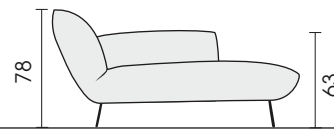

Side view (type 410)

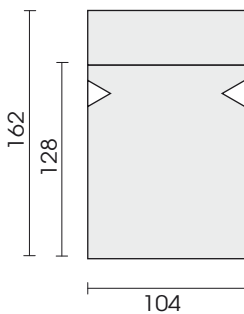

Lounger  
**400**

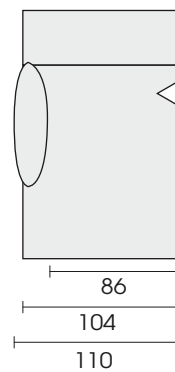

Recamiere armrest left  
**420**

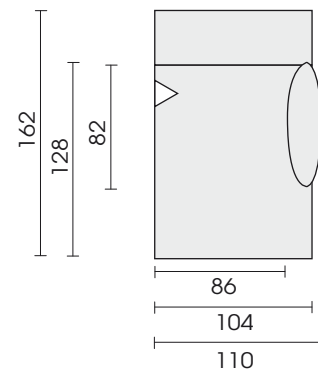

Recamiere armrest right  
**410**

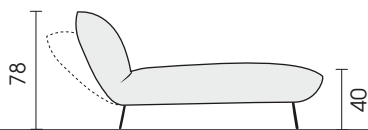

Side view (type 400F)

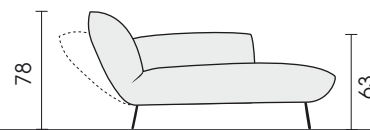

Side view (type 410F)

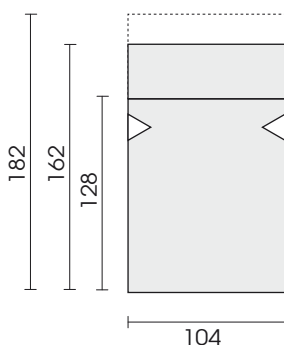

Functional lounger  
**400F**

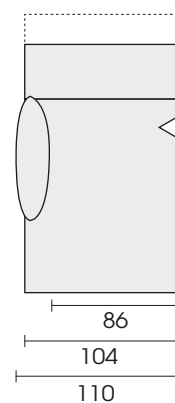

Functional recamiere armrest left  
**420F**

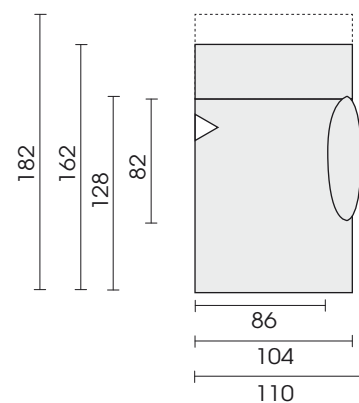

Functional recamiere armrest right  
**410F**

Each piece of furniture is handmade and unique. Deviations to the listed measurements may be caused by:  
1. different upholstery materials (fabric, leather), 2. processing of ticking mats, 3. the pressure to combine individual parts, etc.  
The seat comfort of a sofa type with larger seat depth usually differs from one with lower depth.

Stool:

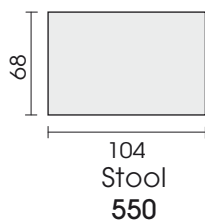

Cushion:



Cushion  
(Tapered cushion)  
(Plain seam)  
78 x 34  
566



Cushion  
(Tapered cushion)  
(Plain seam)  
60 x 40  
967

Combinations:

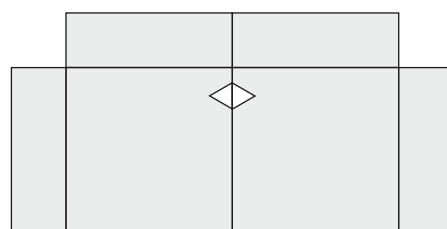
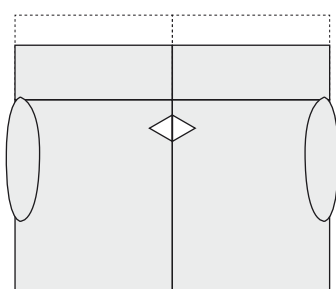
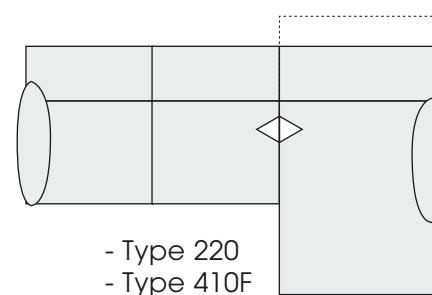
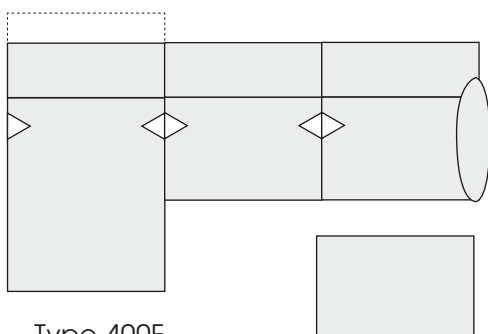
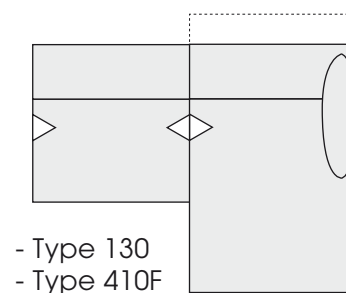
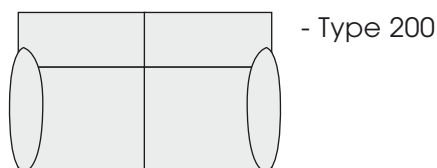

**ATTENTION!**  
**DON'T SIT DOWN ON BACK OR ARMREST.**

Each piece of furniture is handmade and unique. Deviations to the listed measurements may be caused by:  
1. different upholstery materials (fabric, leather), 2. processing of ticking mats, 3. the pressure to combine individual parts, etc.  
The seat comfort of a sofa type with larger seat depth usually differs from one with lower depth.