

# PRODUCT INFORMATION MODEL 2203 TIBOU

© 2022 KURT BEIER & KATI QUINGER



Low back, smaller seat depth,  
manually adjustable head flap



High back, larger seat depth,  
manually adjustable head flap



Individual, flexible adjustment



Motorised adjustable back



Manually adjustable armrest











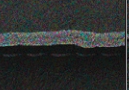

Practical stool

**TIBOU:** YOUR RETREAT AT HOME. AN ISLAND OF PEACE AND STRENGTH. A RETREAT FROM EVERYDAY LIFE! ELEMENTS WITH MODERN HIGH-BACK COMFORT! THE CUBIC BASIC SHAPE COMBINED WITH A CASUAL LOOK AND EXCELLENT FUNCTIONALITY CHARACTERISE THE DESIGN. ADJUSTABLE BACKRESTS AND HEADRESTS ALLOW INDIVIDUAL SITTING AND LYING POSITIONS. THE SEAT DEPTH IS REGULATED WITH THE HELP OF THE FOLDING MECHANISM. THE CORNER SECTION, FUNCTIONALLY SPECIAL, TURNS THE SOFA INTO A COSY CAVE. UNIQUE PIECE PRODUCTION.

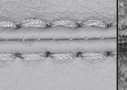

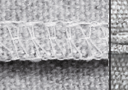
Plastic glides: 5 cm / Floor distance: 5 cm

### Processing options of main seam / decorative seam

	Plain seam	Lap seam	Raw edged	Moccasin seam extra charge	Twin seam extra charge	KR* (zipper piping) extra charge	Overcast seam extra charge	Piping	Two needle seam	Square seam extra charge
										
Fabric	x							x		
Leather	x									
Fur										
Fake fur	x									

It is possible to order main seam or decorative seam either tone in tone like the colours of cover or in the contrasting colours white, nature, grey, rust and black. On request special colours possible.

\*Zipper piping: optionally in the colours black, red, nature or light grey.

01.03.2023

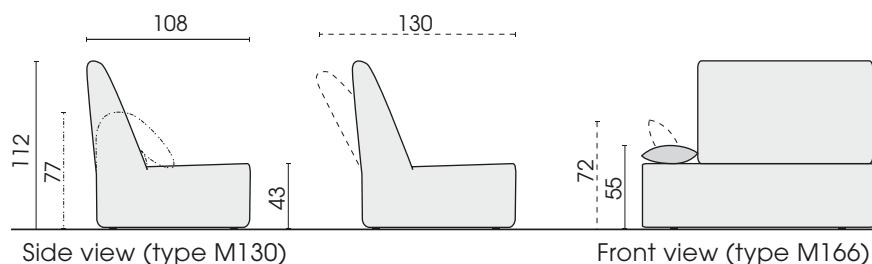

Armrest, type M166



▷ = Connector side

## Single elements with manual headrest, motorised back

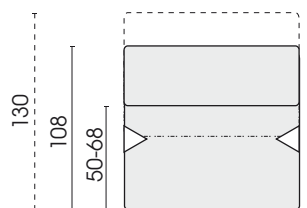

Element,  
back motorised  
**M130**

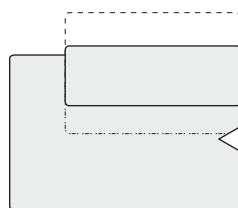

Element with  
add-on stool, left  
back motorised  
**M164**

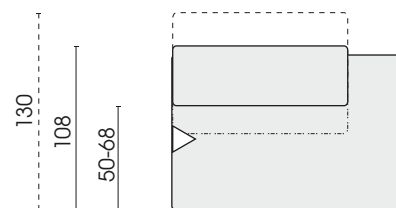

Element with  
add-on stool, right,  
back motorised  
**M163**

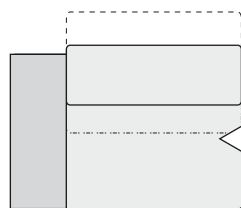

Element,  
armrest left,  
back motorised  
**M166**

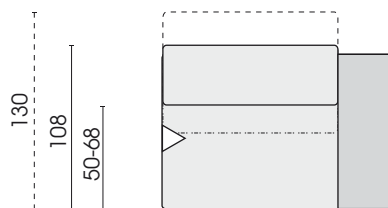

Element,  
armrest right,  
back motorised  
**M165**

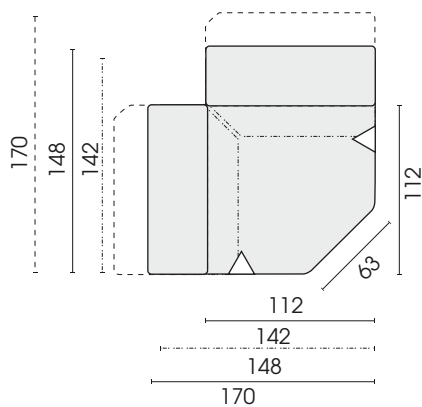

Corner element  
2 backs motorised  
**M700**

Each piece of furniture is handmade and unique. Deviations to the listed measurements may be caused by:  
1. different upholstery materials (fabric, leather), 2. processing of ticking mats, 3. the pressure to combine individual parts, etc.  
The seat comfort of a sofa type with larger seat depth usually differs from one with lower depth.

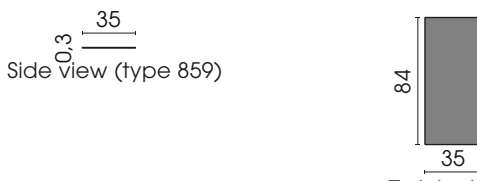

Side view (type 859)

Table top, metal, loosely laid, matching armrest/stool 555, black matt fine structure powder-coated

Table top  
**T23T**

Recamiere with manual headrest, motorised back

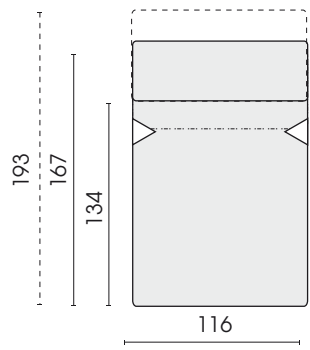

Recamiere, back motorised  
**M400**

Stools

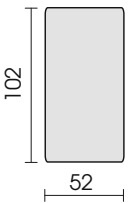

Armrest/Stool  
H = 45 cm  
**555**

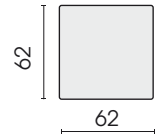

Stool  
H = 42 cm  
**540**

Matching with stool type **540**  
Table to apply on stool **0319 Tao Typ 859**

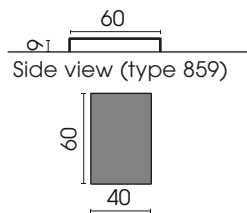

Side view (type 859)

Table to apply on stool, metal  
Stool **540**  
matt black fine structure  
powder-coated  
removable  
**859**

Cushions

Cushions with decorative seams are either tone in tone or contrasting colour possible.

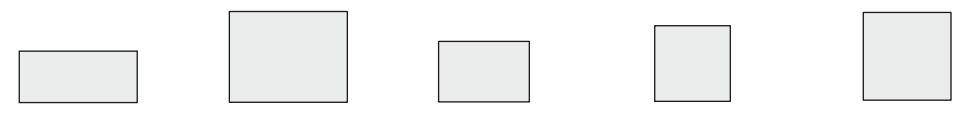

Cushion (tapered cushion) (plain seam) 78 x 34 <b>566</b>	Cushion (tapered cushion) (plain seam) 78 x 60 <b>949</b>	Cushion (tapered cushion) (plain seam) 60 x 40 <b>967</b>	Cushion (with dart) (Fabric: plain seam) (Leather: lap seam) 50 x 50 <b>972</b>	Cushion (with dart) (Fabric: plain seam) (Leder: lap seam) 58 x 58 <b>973</b>
---	---	---	--	--

Each piece of furniture is handmade and unique. Deviations to the listed measurements may be caused by:  
1. different upholstery materials (fabric, leather), 2. processing of ticking mats, 3. the pressure to combine individual parts, etc.  
The seat comfort of a sofa type with larger seat depth usually differs from one with lower depth.

Combinations

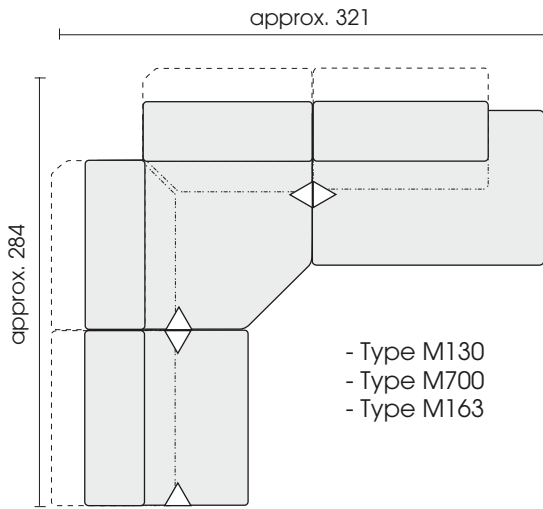

- Type M130
- Type M700
- Type M163

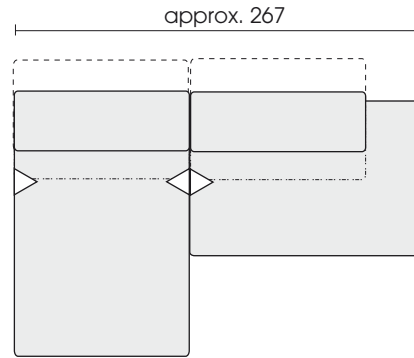

- Type M400
- Type M163

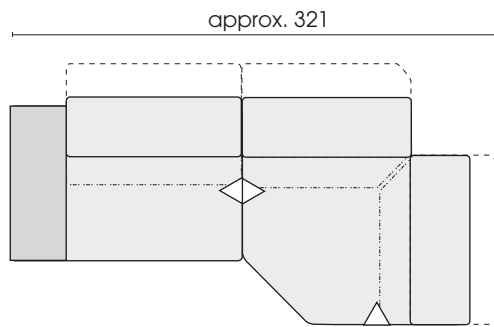

- Type M166
- Type M700

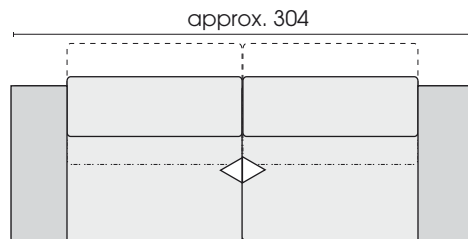

- Type M166
- Type M165
- Type M130
- Type 540
- Type 859

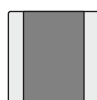
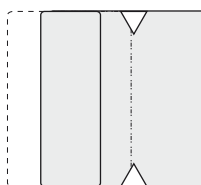

Each piece of furniture is handmade and unique. Deviations to the listed measurements may be caused by:  
 1. different upholstery materials (fabric, leather), 2. processing of ticking mats, 3. the pressure to combine individual parts, etc.  
 The seat comfort of a sofa type with larger seat depth usually differs from one with lower depth.